

■ Base plate Type I Connection M16 Plate 108x35x4 mm

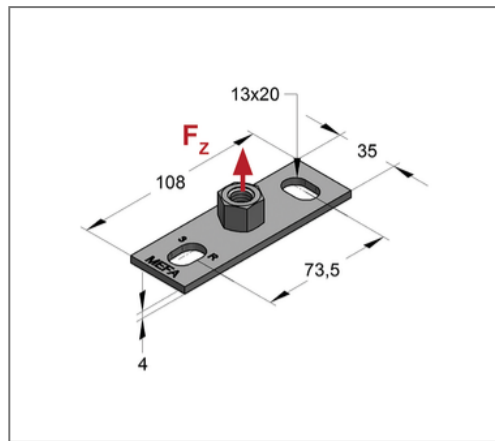
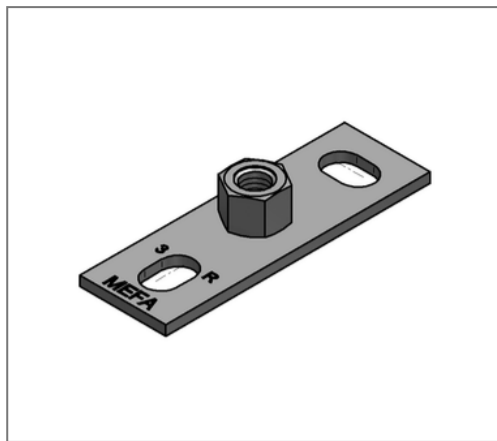

Commercial details

Part no.	059008802
EAN/GTIN	4250928449696
Packing unit	50 pcs
Quantity unit	pcs
Weight	0,163 kg/pc
Product group	05-059
Price unit	100

QR code



Specification

Number of fixing holes	2 pcs
------------------------	-------

Technical data

Material	Steel
Material type	S235
Surface	galvanized
Corrosion category	C2 very high
Surrounding area	Indoor area

Product details

Connection	M16
Length	108 mm
Width	35 mm
Thickness	4 mm
Load F_z	1,5 kN
Elongated hole	13x20 mm
Hole distance lengthwise	73,5 mm