

■ Profile rail slider axial 45 Connection 1 x M10

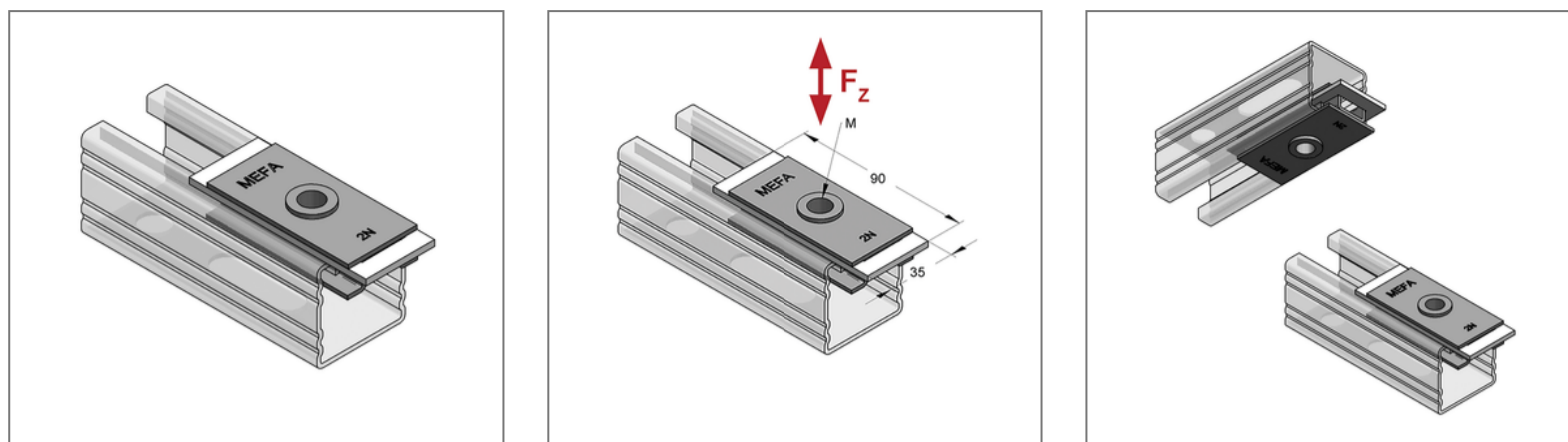

Commercial details

Part no.	077003001
EAN/GTIN	4250928417510
Packing unit	1 pcs
Quantity unit	pcs
Weight	0,120 kg/pc
Product group	04-174
Price unit	1

QR code



Specification

Application Absorption of axial length expansion for standing, hanging or vertical passed pipes in the longitudinal direction of the rail.

Technical data

Surface	galvanized
Material sliding element	Steel
Material type sliding element	S235
Material sliding stripe	Plastic
Material name sliding stripe	Polyamide 6
Corrosion category	C2 very high
Surrounding area	Indoor area
min. temperature resistance	-30 °C
max. temperature resistance	110 °C

Product details

Width	35 mm
Length	90 mm
Connection	1 x M10
Number of connections	1
Thread M	M10
Static friction factor	0,2 - 0,3
Load F_z	2 kN