

■ Spring bearing FL Type 2 - 10500 F 0 - 10677 N max. spring deflection 26,5 mm

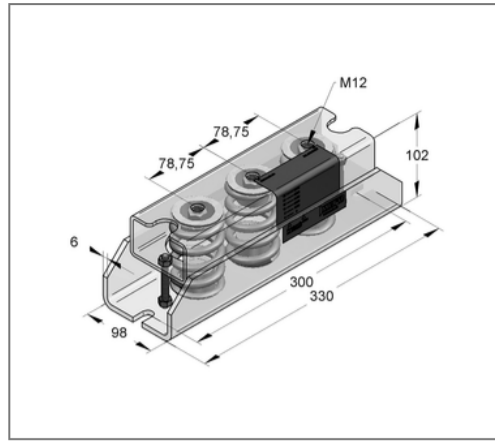
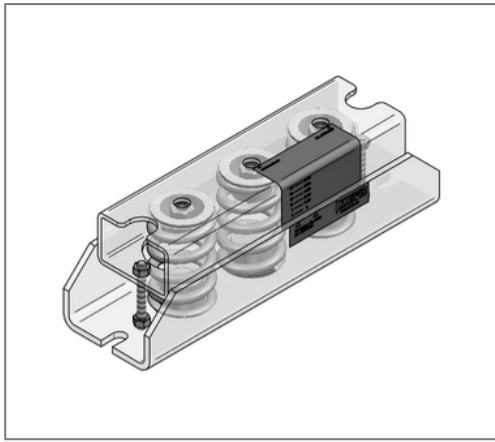

Commercial details

Part no.	07919105
EAN/GTIN	4250928419064
Packing unit	1 pcs
Quantity unit	pcs
Weight	6,10 kg/pc
Product group	03-079
Price unit	1

QR code



Specification

Application	Spring isolators for the elevation of piping or area
Number of springs	3

Technical data

Material	Steel
Material type	S235
Surface	galvanized
Corrosion category	C2 very high
Surrounding area	Indoor area

Product details

Connection	M12
Width	98 mm
Height	102 mm
Length	330 mm
Spring rate	402,9 N/mm
max. spring deflection	26,5 mm
max. load range	10677 N