

## ■ Spring bearing FL Type 2 - 7200 F 0 - 7118 N max. spring deflection 26,5 mm

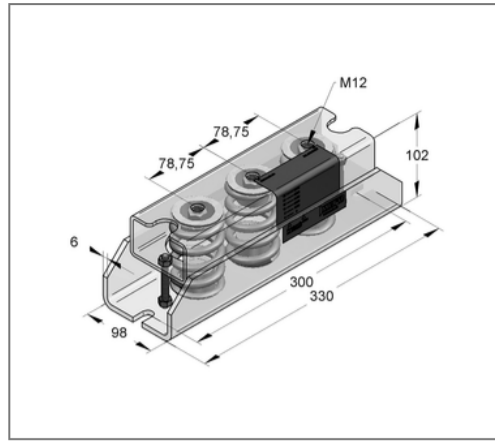
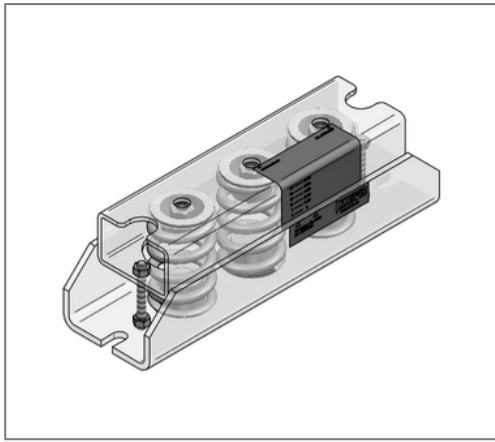

### Commercial details

Part no.	07919072
EAN/GTIN	4250928419057
Packing unit	1 pcs
Quantity unit	pcs
Weight	5,72 kg/pc
Product group	03-079
Price unit	1

### QR code



### Specification

Application	Spring isolators for the elevation of piping or area
Number of springs	2

### Technical data

Material	Steel
Material type	S235
Surface	galvanized
Corrosion category	C2 very high
Surrounding area	Indoor area

### Product details

Connection	M12
Width	98 mm
Height	102 mm
Length	330 mm
Spring rate	268,6 N/mm
max. spring deflection	26,5 mm
max. load range	7118 N