

## ■ Fixpoint bracket HV 3 64-406 mm Fy 30 kN 164-216 mm

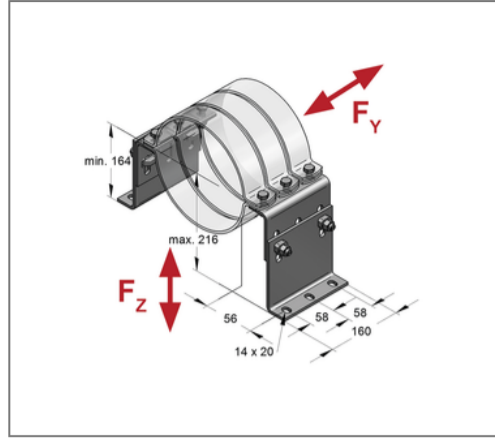
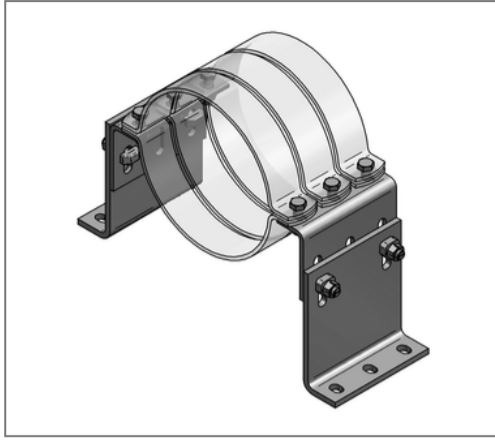

### Commercial details

Part no.	00200407/fvz
EAN/GTIN	4250928400024
Packing unit	1 pcs
Quantity unit	pcs
Weight	5,68 kg/pc
Product group	03-002
Price unit	1

### QR code



### Certification



### Specification

Application area	Height-adjustable bracket for fixing piping without sound insulation. To be used as a fixed point in conjunction with pipe clamp Titan HD.
Pipe clamp type	Titan HD

### Product details

min. outside pipe diameter	64 mm
max. outer pipe diameter	406 mm
Length	160 mm
Load $F_Y$	30 kN
Load $F_Z$	18 kN
Number of pipe clamps	3
min. axis height	164 mm
max. axis height	216 mm
Dimension angle stilt	160x153x6 mm
Dimension side part	160x100x6 mm

### Technical data

Material	Steel
Material type	S235
Surface	hot-dip galvanized
Corrosion category	C4 high / C5 medium
Surrounding area	Indoor and outdoor areas
Tightening torque T-lock	120 Nm
Tightening torque pipe clamp	60 Nm

### Remark

Scope of delivery	2x angle (foot part), 2x angle (side part), 4x CENTUM® T-lock M12x40, 4 / 6x hexagon bolts and nuts
-------------------	---