

■ Gewindestift DIN 976-1 M10 x 50 mm gvz FK 4.6

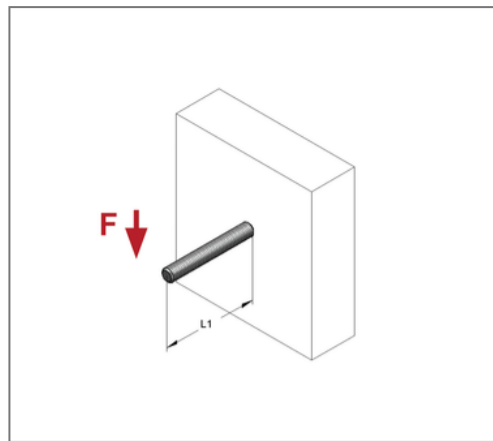
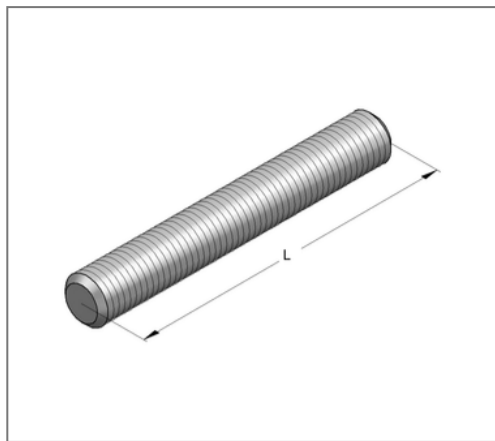
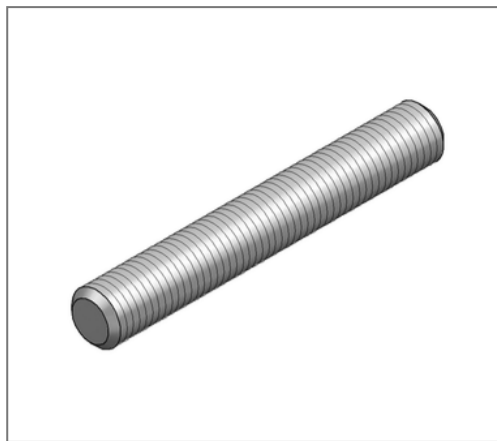

Kaufmännische Details

Artikelnummer	0731064
EAN/GTIN	4250928416704
VPE	100 St
Mengeneinheit	St
Gewicht	0,0253 kg/St
Rabattgruppe	05-173
Preiseinheit	100

QR Code



Technische Daten

Material	Stahl
Oberfläche	galvanisch verzinkt
Festigkeitsklasse	4.6

Produktdetails

Gewinde	M10
Länge L	50 mm
zul. Zuglast	14,2 kN
zul. Zuglast FWD 30	1,27 kN
zul. Zuglast FWD 60	0,72 kN
zul. Zuglast FWD 90	0,55 kN